

MVP-50T

Installation Checklist

1213062

Rev. B: 5/7/09

Aircraft Make: _____ Model: _____ N#: _____

Note: Refer to MVP-50T Installation Instructions II 1211061 for details on all the following steps.

- Read Warranty/Agreement, Important Notice and Important Information and Initial Checkout.
- Review the “EDC Wiring Work Sheets” for the top, middle and bottom EDC connectors. This is an important step to insure a fast, easy and accurate installation. The work sheets are packaged with each of the three EDC wire harnesses.
- Verify you have all the probes, transducers, modules, etc, listed on the “EDC Wiring Work Sheets.”
- Install the MVP Display unit. E.I.’s sub-panel may make installation much easier.
- Install all the Temperature Probes and Pressure Transducers.

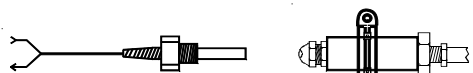
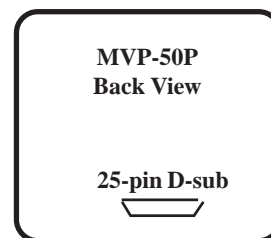

- Install the Interface Circuits for each Annunciator to be displayed on the MVP. _____ VI-221 _____
- Install the Interface Circuits for each Flap or Trim indication to be displayed on the MVP. _____ VI-221 _____
- Install the Interface Circuits for each Gear Position Indicator to be displayed on the MVP. _____ VI-221 _____
- Install the CO detector (optional).

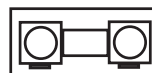

- Install the Shunt in the electrical system or interface to the existing shunt.
- Install the Fuel Flow Transducer. If the aircraft is equipped with a pressure carburetor, install a Differential Module and two Fuel Flow Transducers.

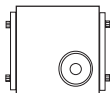

- Install the P-300 Capacitive Probe, P-300M Magnetic Float or the RFLM-4-xx to interface with existing Resistance Fuel Level Probe.

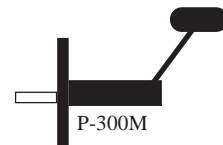
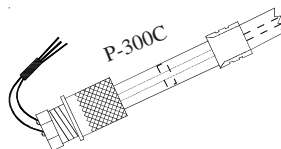



- Install the AV-17CP Voice Alarm Control Panel.

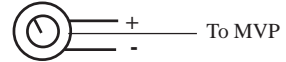

The MVP has an electric eye to internally control display intensity. If external intensity control is required, install the CP-1-MVP Intensity Control Pot.



Install the Master Warning and Caution Lights.  

Install the EDC-33P Engine Data Converter (black box).

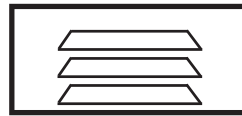

EDC: 37-Pin D-sub Connectors

Top
Middle
Bottom

Route and connect the EDC wires to Power, Ground and all Probes, Transducers, Modules, etc.

Route and connect the MVP wires to Power, Ground and all accessories.

Route and connect the EDC RS422 wires to the MVP.

Perform the Power-on Checkout:

Perform all the steps in the "MVP-50T Setup Checklist."

Perform the Ground Run Checkout.

Perform the First Flight Checkout.

Read the Warranty/Agreement and Important Notice in the MVP-50T Operating Instructions.

Installer's Signature: _____ Date: _____

MVP-50T

System Wiring Block Diagram

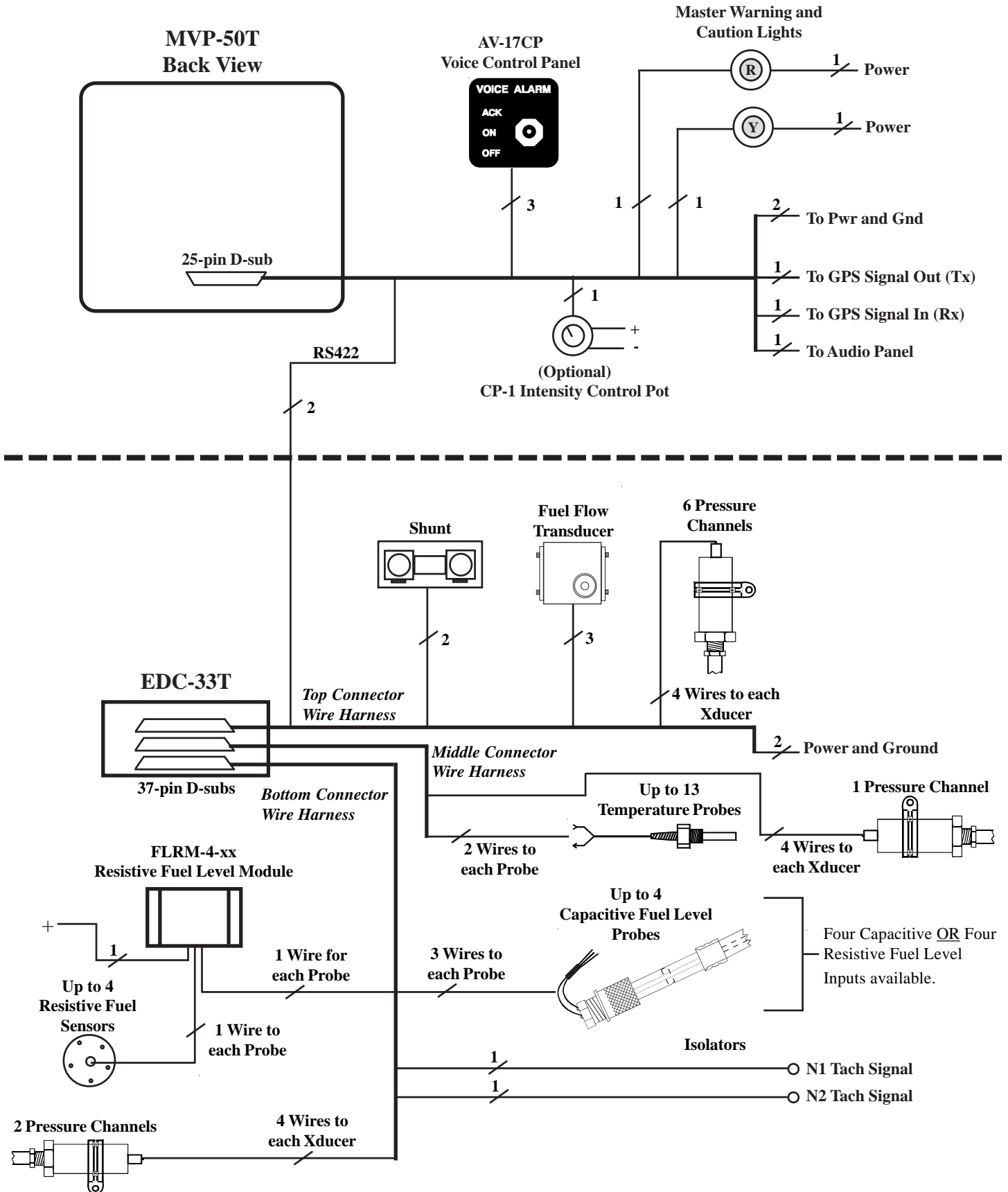

Template for laying out an Aircraft Panel

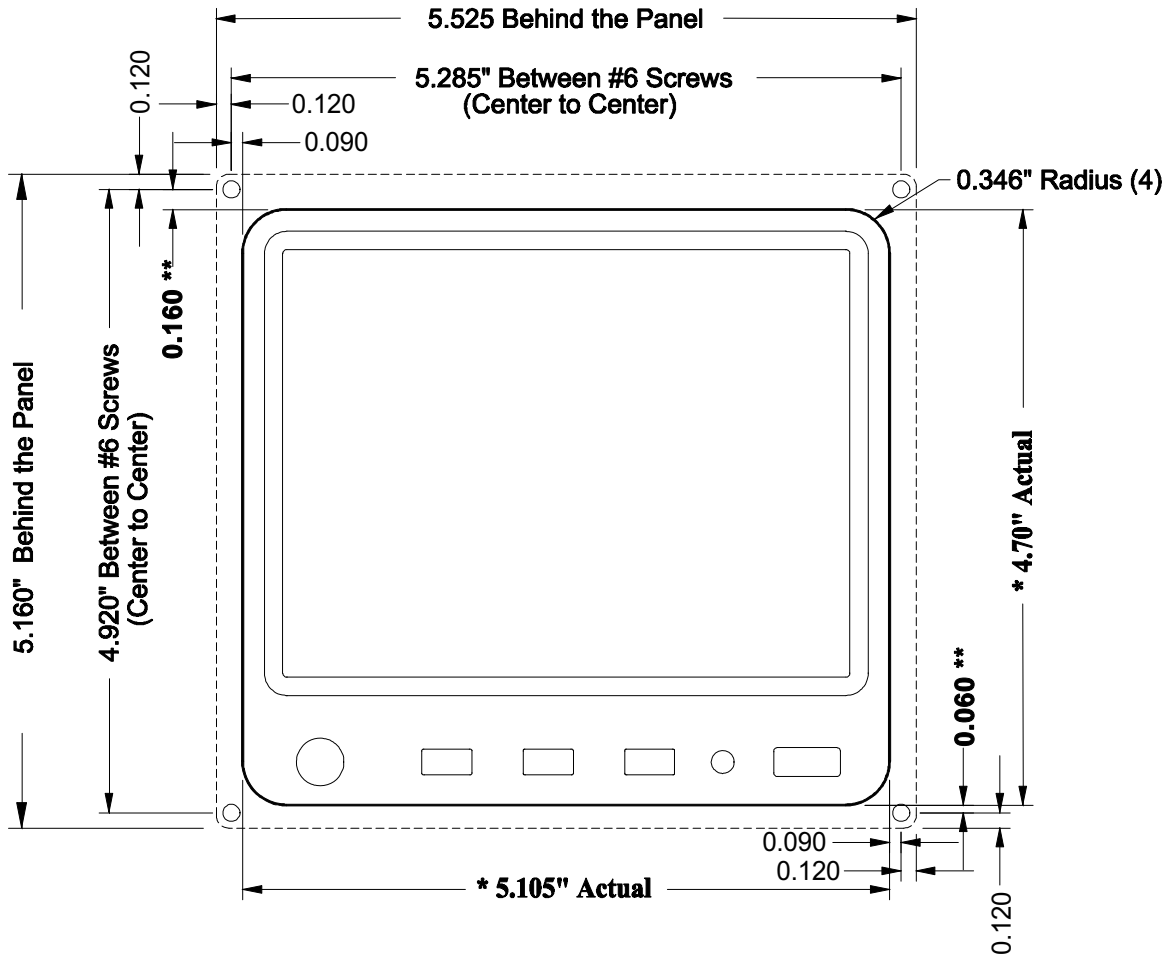

*** Cutout**

*** Panel cutout should be slightly larger than actual to allow for clearance and panel paint.**

**** Caution:**
Panel cutout is not equidistant between mounting holes.

Depth: 2.425" Behind the Panel

ELECTRONICS INTERNATIONAL INC.		
DATE: 4/20/05	DRAWN BY: R.R.	APPVD. BY: R.R.
SCALE: None		REV: Rev. C: 5/26/05
TOLERANCE: +/- .010"		P/N:
MATERIAL: N/A		D/N:
NEXT ASSEM:		420051
TITLE: MVP-50 Aircraft Panel Cutout		